



Product Description

The POWERV8 uses a high power handling 200mm (8.00") version of Tannoy's exclusive point source, constant directivity Dual Concentric™ drive unit technology. The robust chassis construction, an LF cone of reinforced paper terminated with a twin roll cambric surround and a 25mm (1.00") titanium domed, neodymium magnet equipped HF all contribute high power output with high sensitivity. With the HF mounted in the throat of the LF driver these two sources are coincidentally aligned into a single point source. This is a configuration, exclusive to the Dual, delivers a smooth and uniform frequency response over a wide area. The CAD designed Tulip WaveGuide™ combines 90 degrees conical dispersion for optimum coverage, forward gain and excellent acoustic impedance characteristics.

Delivering impressive levels of accuracy and performance, the POWERV8 is equipped with a highly efficient, flexible and reliable Class D power amplifier incorporating a switching power supply. The amplifier section and power supply were developed simultaneously and therefore optimally matched to minimise noise and enhance stability. The power module combines light, efficient and cool-running amplification, comprehensive driver protection and equalisation into a single compact unit. Clean, undistorted sound is delivered, even when driven at very high power levels. No cooling fans are required so the system runs quietly and is not prone to internal dust contamination.

The POWERV8 capitalises on the integrated design concept as every component part and their interaction is fully optimised. All signal processing functions have been precisely tailored; crossover frequencies and slopes, EQ, phase corrections and limiting. LED's on the rear panel indicate signal presence, signal activity, and power. Signal input and audio link are via XLR, while the mains connector is a Neutrik locking Powercon type.

A switch on the rear panel of the full range models allows selection between Full Range or High Pass modes, with High Pass allowing a speaker to be mounted in close proximity to a boundary or simply to increase headroom. High pass mode also enables a simple top box and subwoofer combination to be created without the need for an external crossover. Two low pass setting options on the subwoofer amplifiers fully optimise integration with the full range units.

A compact solution for high quality music and speech reproduction in smaller venues, this versatile loudspeaker also has, due to effective acoustic matching to the other POWERV Series models, a wide range of applications in more space-restricted areas within larger installations, including nightclub infill, theme bars, performing arts centres, high quality public address, theme parks, leisure venues, audio visual, houses of worship and 'dry hire' rental.

Speaker placement flexibility is enhanced by the dispersion characteristics of the Dual driver; allowing either vertical or horizontal mounting without any compromise to sound quality or acoustic performance. Used as a low profile stage monitor, the conical coverage pattern gives the performer greater freedom of movement off axis than allowed by conventional horn loaded designs.

Available in black or white, the asymmetric cabinet profile is flexible and discreet in either fixed installations or on the road.

Features

- 200mm (8.00") Dual Concentric™ full range, point source, constant
- Controlled conical dispersion for optimum coverage and forward gain
- Compact, versatile enclosures
- Rugged, highly efficient Class D amplification with universal power supply
- Integral carry handle
- Multiple flying points and accessory mounting hardware options

Applications

- Nightclub infill
- Theme bars
- Performing arts centres
- High quality public address
- Theme parks
- Leisure venues
- Audio visual
- Houses of worship
- 'Dry hire' rental

Tannoy United Kingdom
Tannoy North America
Tannoy Deutschland
Tannoy France

T: 00 44 (0) 1236 420199
T: 00 1 (519) 745 1158
T: 00 49 (180) 1111 881
T: 00 33 (0)1 7036 7473

E: enquiries@tannoy.com
E: inquiries@tannoyna.com
E: anfragen@tannoy.com
E: ventes@tannoy.com

tannoy®.com



TECHNICAL SPECIFICATIONS

System	POWERV8	
System Type	Full Range - Vented	
Frequency Response (-3dB) ⁽¹⁾ Full Range Mode	80Hz - 30kHz	
Frequency Range (-10dB) ⁽¹⁾ Full Range Mode	67Hz - 40kHz	
Frequency Response (-3dB) ⁽¹⁾ High Pass Mode	120Hz - 30kHz	
Frequency Range (-10dB) ⁽¹⁾ High Pass Mode	100Hz - 40kHz	
Dispersion (-6dB)	90 degrees conical	
Driver Complement	1 x 200mm (8.00") Dual Concentric™	
Crossover	Passive 1.7kHz	
Directivity Factor (Q)	6.8 averaged 1kHz to 10kHz	
Directivity Index (DI)	7.9 averaged 1kHz to 10kHz	
Rated Maximum SPL ⁽²⁾ Average Peak	113dB 119dB	
Distortion		
10% Full Power (8.9V)	2nd Harmonic	3rd Harmonic
250Hz	0.12%	0.15%
1kHz	0.23%	0.84%
10kHz	1.35%	0.16%
1% Full Power (2.8V)	2nd Harmonic	3rd Harmonic
250Hz	0.16%	0.14%
1kHz	0.09%	0.53%
10kHz	0.53%	0.17%
Crossover	1.7kHz Passive	

PSU Specifications

Input Connector	Locking Neutrik Powercon
Voltage Selection	Automatic (115 / 230V, 45 - 65Hz)
Type	High current, high freq. switch-mode
Efficiency	>90% typical
Input voltage	100v / 115v / 230v nominal +/-10%
Mains fuse	External
Fuse type	T10AT
Other features	Automatic soft start

Notes:

- (1) Average over stated bandwidth. Measured at 1 metre on axis.
(2) Unweighted pink noise input, measured at 1 metre in an anechoic chamber

A full range of measurements, performance data, CLF and Ease™ Data can be downloaded from www.tannoy.com

Full independent verification of published specifications carried out by NWAAL Labs, California can also be obtained from the downloads section of www.tannoy.com

Tannoy operates a policy of continuous research and development. The introduction of new materials or manufacturing methods will always equal or exceed the published specifications, which Tannoy reserves the right to alter without prior notice. Please verify the latest specifications when dealing with critical applications.

Ordering Information

PART NUMBER	MODEL NAME	COLOUR	PACKED QUANTITY
8001 4260	POWERV8	Black	2
8001 4261	POWERV8	White	2

Construction	
Enclosure	17 litre vented and internally braced 15mm (0.62") birch plywood enclosure 15mm (0.62") MDF front baffle
Finish	Textured black or white paint with custom colours on request Powder coated steel grille with reticulated foam behind
Connectors	1 x female XLR (input) 1 male XLR (link) 1 x Neutrik Powercon
Controls & Indicators	Level control Power LED (Blue) Signal LED (Green) Limit LED (Red) Full range / High pass switch (110Hz) Power switch
Fittings	4 x M10 inserts for flying hardware 2 x M10 yoke bracket inserts 1 x recessed carrying handle Blanking plate for optional VTH pole mount
Dimensions (H x W x D)	388 x 280 x 275mm 15.13 x 10.92 x 10.73"
NET Weight	10.5kg 23.1lbs
Electronics	
Maximum signal input for clip	Input attenuator at minimum: +18dBu Input attenuator at maximum: +5dBu
Output noise	-105dB unweighted, referenced to maximum output (22kHz bandwidth)
Efficiency	>90% typically
Damping Factor	400 ref 8 Ohms
Distortion	<0.05% @ 1kHz -3dB output (22kHz bandwidth)
Input Impedance	5.6kOhms unbalanced 11.2kOhms balanced
Protection systems	Over Current Excessive over current causes shutdown Temperature Limiters applied Brownout Automatic protection & recovery Mains Inrush current limiting Indicators 1x Limit LED 1x Signal LED 1x Power LED
Number of channels	One
System Type	Class D



PERFORMANCE MEASUREMENTS

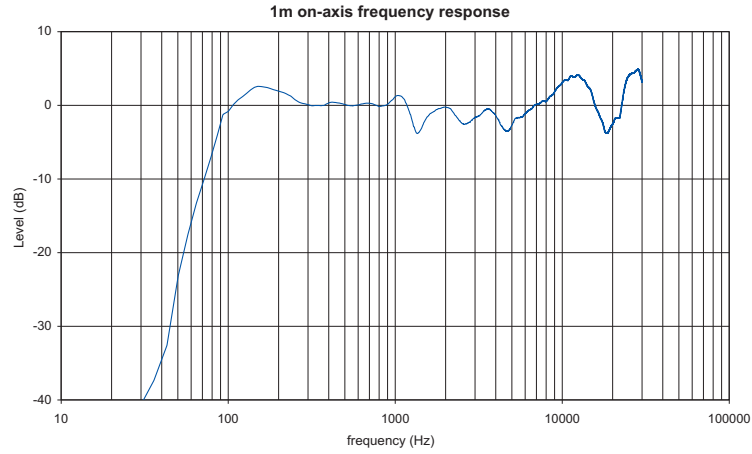

ANECHOIC
FREQUENCY
RESPONSE

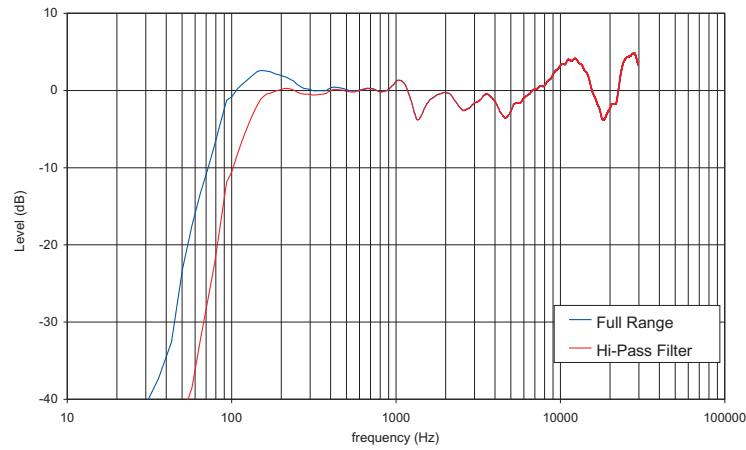

HIGH PASS FILTER
ON / OFF

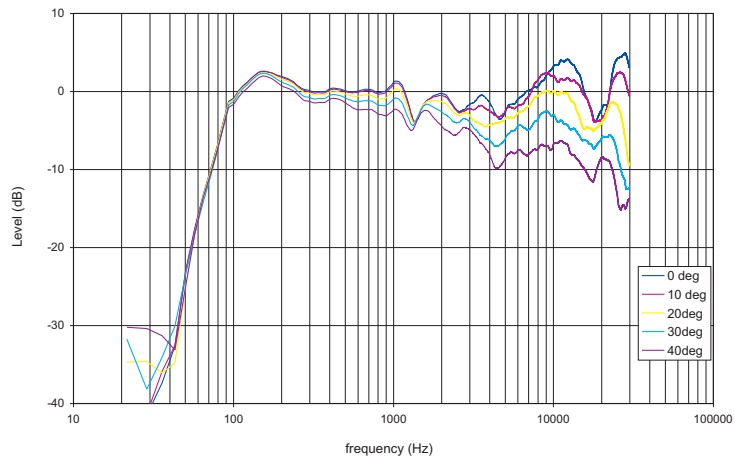

OFF AXIS
RESPONSE

Tannoy United Kingdom
Tannoy North America
Tannoy Deutschland
Tannoy France

T: 00 44 (0) 1236 420199
T: 00 1 (519) 745 1158
T: 00 49 (180) 1111 881
T: 00 33 (0)1 7036 7473

E: enquiries@tannoy.com
E: inquiries@tannoyna.com
E: anfragen@tannoy.com
E: ventes@tannoy.com

tannoy®.com



PERFORMANCE MEASUREMENTS

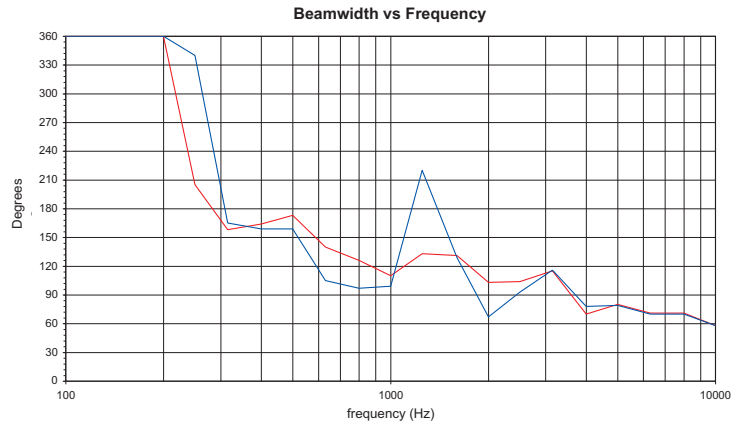

BEAMWIDTH

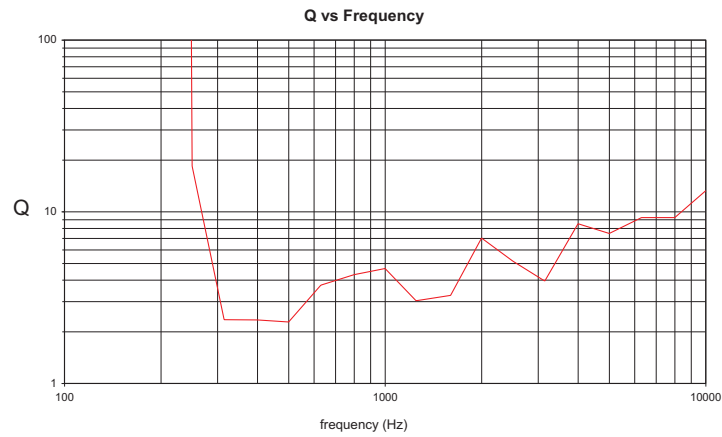

DIRECTIVITY INDEX

Tannoy United Kingdom
 Tannoy North America
 Tannoy Deutschland
 Tannoy France

T: 00 44 (0) 1236 420199
 T: 00 1 (519) 745 1158
 T: 00 49 (180) 1111 881
 T: 00 33 (0)1 7036 7473

E: enquiries@tannoy.com
 E: inquiries@tannoyna.com
 E: anfragen@tannoy.com
 E: ventes@tannoy.com

tannoy®.com



PERFORMANCE MEASUREMENTS POLAR PLOTS (1/3 OCTAVE)

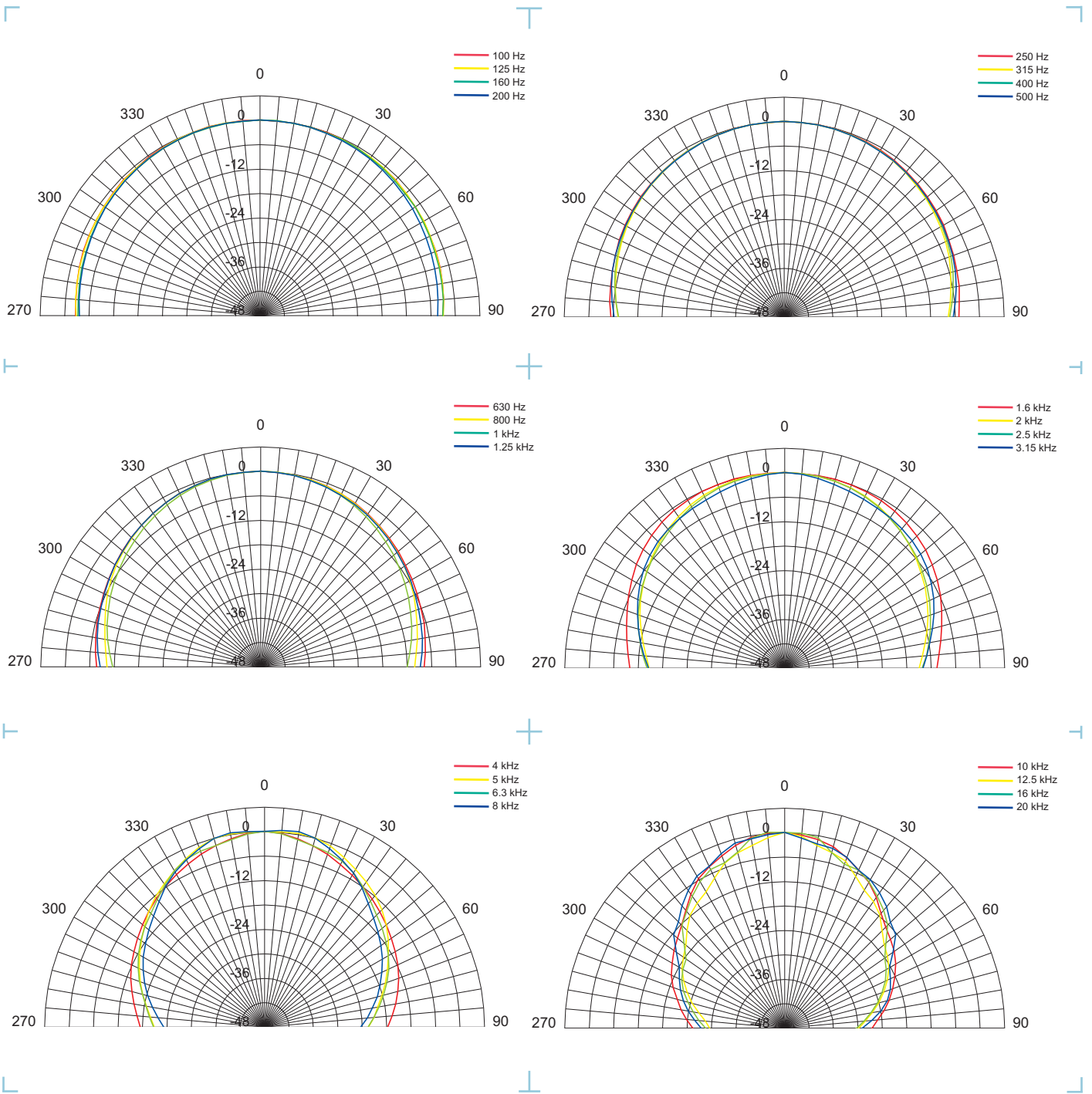

Tannoy United Kingdom
 Tannoy North America
 Tannoy Deutschland
 Tannoy France

T: 00 44 (0) 1236 420199
 T: 00 1 (519) 745 1158
 T: 00 49 (180) 1111 881
 T: 00 33 (0)1 7036 7473

E: enquiries@tannoy.com
 E: inquiries@tannoyna.com
 E: anfragen@tannoy.com
 E: ventes@tannoy.com

tannoy®.com



PERFORMANCE MEASUREMENTS POLAR PLOTS (1/3 OCTAVE)

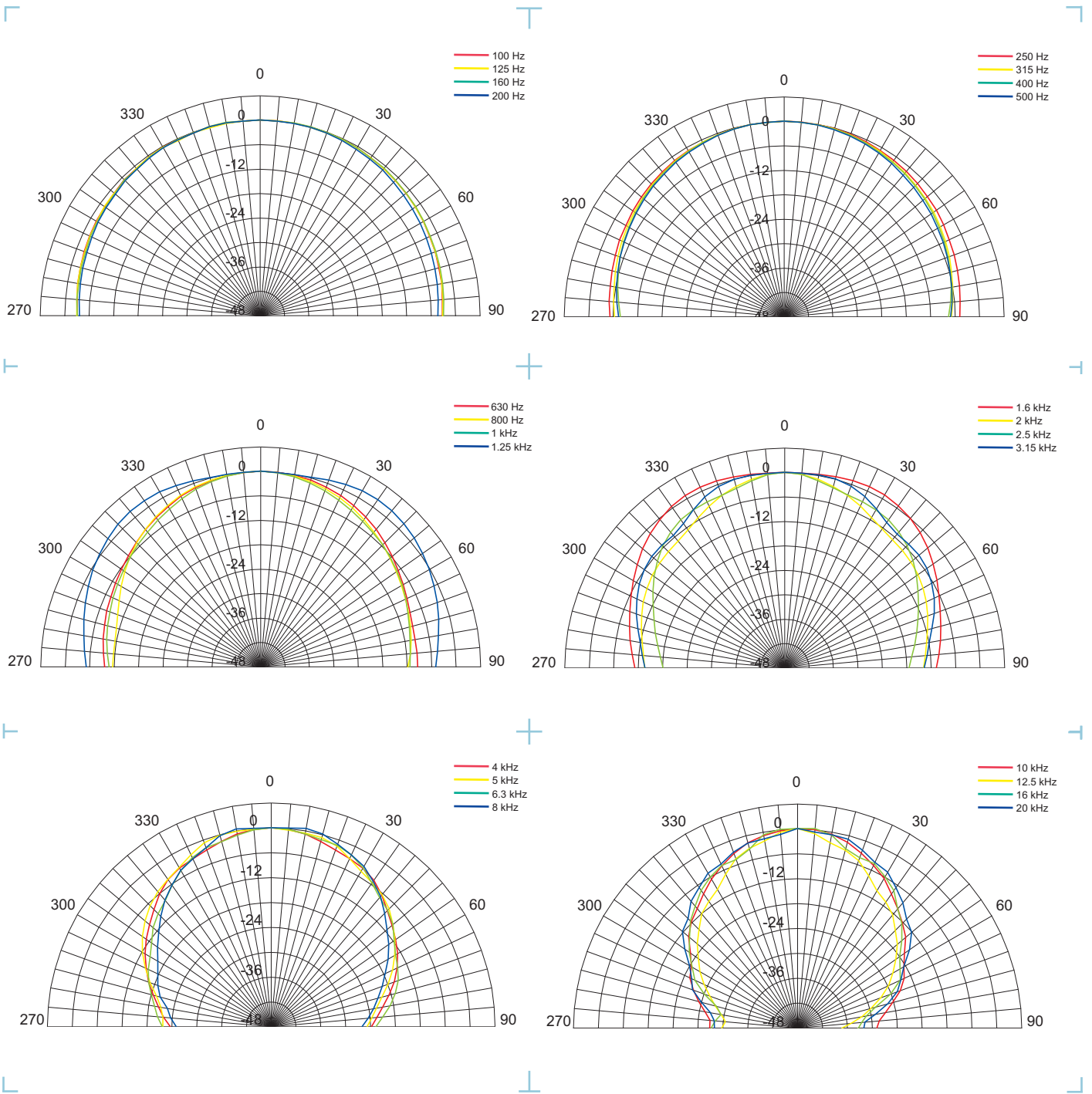

Tannoy United Kingdom
 Tannoy North America
 Tannoy Deutschland
 Tannoy France

T: 00 44 (0) 1236 420199
 T: 00 1 (519) 745 1158
 T: 00 49 (180) 1111 881
 T: 00 33 (0)1 7036 7473

E: enquiries@tannoy.com
 E: inquiries@tannoyna.com
 E: anfragen@tannoy.com
 E: ventes@tannoy.com

tannoy®.com



POWERV8

TANNOY®

DIMENSIONAL SKETCHES

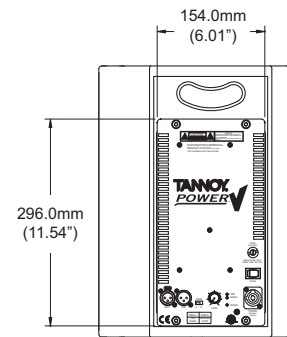
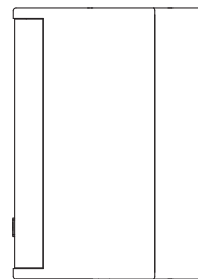
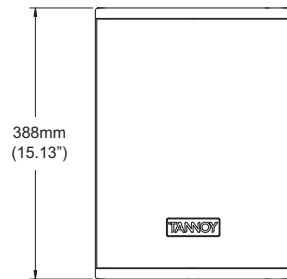
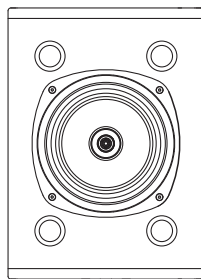
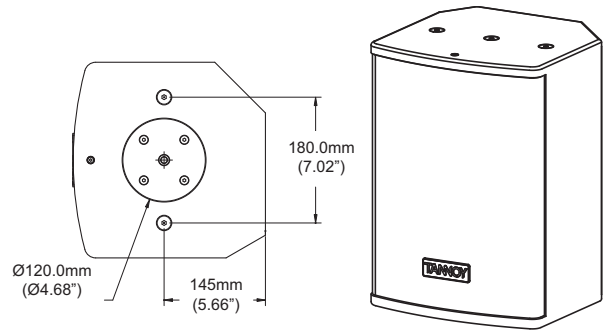
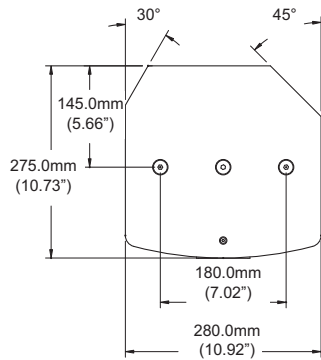

Tannoy United Kingdom
Tannoy North America
Tannoy Deutschland
Tannoy France

T: 00 44 (0) 1236 420199
T: 00 1 (519) 745 1158
T: 00 49 (180) 1111 881
T: 00 33 (0)1 7036 7473

E: enquiries@tannoy.com
E: inquiries@tannoyna.com
E: anfragen@tannoy.com
E: ventes@tannoy.com

tannoy.com



POWER V8

TANNOY®

OPTIONAL ACCESSORIES & MOUNTING OPTIONS

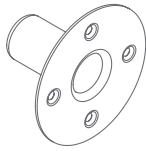

VTH

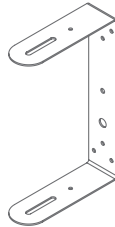

V8Y

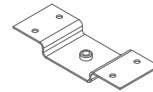

VCS

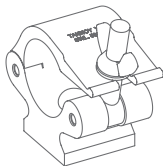

VPC

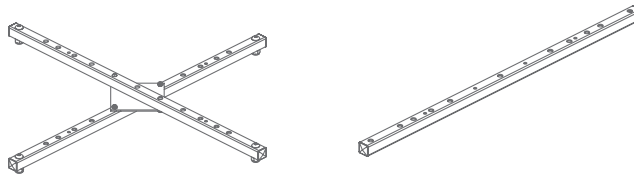

VCB4

VCB2

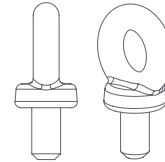

VEB

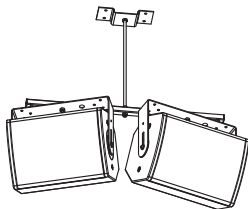

POWERV8 Cluster x 2

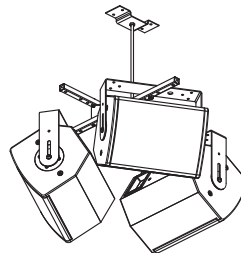

POWERV8 Cluster x 3

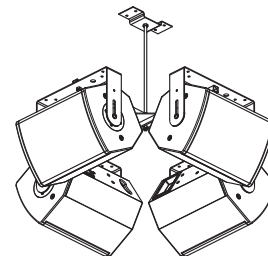

POWERV8 Cluster x 4

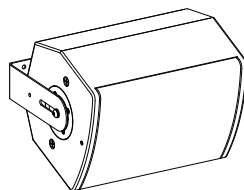

POWERV8 and V8Y Bracket

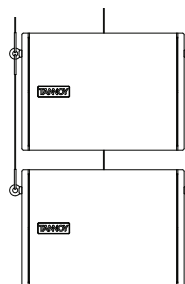

POWERV8 Flying X 2

Ordering Information

PART NUMBER	MODEL NAME	COLOUR	PACKED QUANTITY
8001 2700	V8Y	Black	1
8001 2710	V8Y	White	1
8001 2740	VCB 2	Black	1
8001 2750	VCB 2	White	1
8001 2760	VCB 4	Black	1
8001 2770	VCB 4	White	1
8001 2820	VEB	-	1
8001 2830	VCS	Black	1
8001 2840	VCS	White	1
8001 2860	VTH	Black	1
8001 2870	VTH	White	1
8001 2850	VPC	-	1

Tannoy United Kingdom
Tannoy North America
Tannoy Deutschland
Tannoy France

T: 00 44 (0) 1236 420199
T: 00 1 (519) 745 1158
T: 00 49 (180) 1111 881
T: 00 33 (0)1 7036 7473

E: enquiries@tannoy.com
E: inquiries@tannoyna.com
E: anfragen@tannoy.com
E: ventes@tannoy.com

tannoy.com



Architectural specifications

The loudspeaker shall consist of a 200mm (8.00") full range, point source Dual Concentric™ transducer. The low and high frequency elements shall be driven by an integrated single channel Class D amplifier through an internal passive crossover network operating at 1.7kHz. Performance of the loudspeaker shall meet or exceed the following criteria: Frequency response measured at 1 metre on axis with swept sine wave shall be 80Hz to 30kHz (-3dB) in full range mode and 120Hz to 30kHz in high pass mode. Rated average SPL shall be 113dB (anechoic) on axis at 1 metre. The dispersion of the loudspeaker shall be 90 degrees conical (-6dB).

The enclosure shall be an optimally tuned 17 litre vented 15mm (0.62") birch ply cabinet with 15mm (0.62") MDF front baffle. Connectors shall be 1 x female XLR (input), 1 x male XLR (link) and 1 x Neutrik Powercon. The speaker shall be fitted with the following controls and indicators: level control, blue power LED, green signal LED, red limit LED, full range / high pass switch (110Hz) and a power switch. The enclosure shall be fitted with 4 x integral M10 inserts for flying hardware and 2 x M10 yoke bracket inserts. There shall be one carry recessed handle and a blanking plate for an optional pole mount adaptor.

The enclosure shall not exceed the following dimensions: 388 x 280 x 275mm or 15.13 x 10.92 x 10.72" (H x W x D).

The loudspeaker shall be the Tannoy... POWERV8.

Tannoy United Kingdom
Tannoy North America
Tannoy Deutschland
Tannoy France

T: 00 44 (0) 1236 420199
T: 00 1 (519) 745 1158
T: 00 49 (180) 1111 881
T: 00 33 (0)1 7036 7473

E: enquiries@tannoy.com
E: inquiries@tannoyna.com
E: anfragen@tannoy.com
E: ventes@tannoy.com

tannoy®.com

